

NORPA

www.norpa.com

TECHNICAL INFORMATION

RAW MATERIALS

INDUSTRIAL SECTIONAL DOOR

PB-2

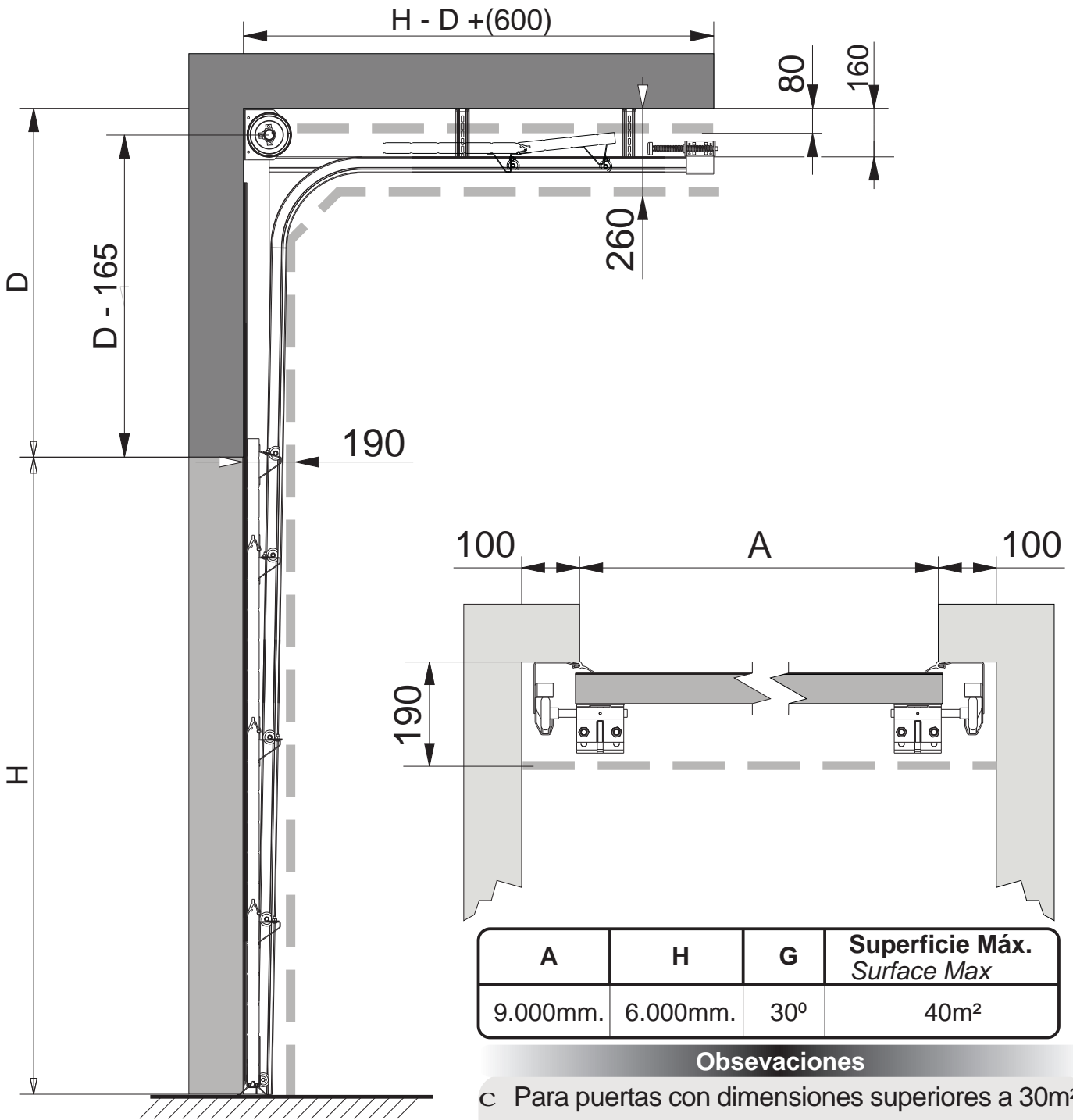

A	H	G	Superficie Máx. Surface Max
9.000mm.	6.000mm.	30°	40m ²

Obsevaciones

- c Para puertas con dimensiones superiores a 30m².
consultar.
- c Para $A >$ de 8.000mm.
Espacios laterales 120mm.

Observations

- c For doors with dimensions more than 30m².
consult.
- c For $A >$ 8.000mm.
Side spaces 120mm.

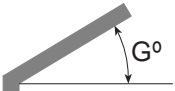

G°

Maximum inclination of the Superior Guides

Inclinación máxima de las guías superiores

Limite maximo de invasión de la puerta incluidos accesorios

Maximum limit of space occupied by the door including Accessories



TECHNICAL INFORMATION RAW MATERIALS INDUSTRIAL SECTIONAL DOOR

CONTENTS

- 1.- PRESENTATION E
- 2.- CONSTRUCTION CHARACTERSTICS E
- 3.- CONSTRUCTION VARIANTS E
- 4.- RAW MATERIAL E
 - A.- SANDWICH PANEL E
 - B.- GUIDE SYSTEMS OF STEEL E
 - C.- TORSION SPRINGS E
 - D.- SAFETY SYSTEMS E
 - E.- STEEL CABLES E
 - F.- HARDWARE E
- 5.- TECHNICAL REGULATIONS ACCORDING TO EUROPEAN EC-13241-1 E
- 6.- VARIANTS IN THE GUIDES E

1.- PRESENTATION

The Norpa Industrial sectional door fabricated with the sandwich panel is one of our best options for the proper closing and functioning of the Industrial warehouses, factories and large sheds which enhances both thermal and acoustic insulation. Norpa, S.L. has elaborately prepared this drawing out from the efforts of all the concerned departments to achieve a product of the highest quality in terms of performance, not only offering protection at different temperatures, but also against various noise levels, and offers the best guarantees in terms of quality, safety, performance and durability .

2.- CONSTRUCTION CHARACTERSTICS

Norpa, S.L. provides it's Industrial door with all the components necessary for a safe and easy installation on site.

Roll formed panel, machined and assembled ready for quick and easy placement of the different hardware that will enable its assembly.



Rolling Guides perfectly assembled, machined and ready for a mooring site / pre-steel frames and reception of the panels

PERIMETER SEALS: High quality EPDM side, bottom and top seals that will make it possible to seal the door tightly are included in the closure profiles and their corresponding panels. The side seals are supplied in the box with the hardware taking into consideration the simplicity of its assembly in the profiles indicated of the guides and also to avoid possible damage that might suffer in the process of packing and transportation. The references are 60VA 93 for the bottom seal Profile, 60VA 94 for top sealing profile and 60-VA-101 for the side seal profile.

SPRINGS: Norpa, S.L. administers all of its Industrial sectional doors with adequate number of springs obtaining thus, a levelling of the door with high precision, ensuring that the installation of these heavy elements is not so difficult for technicians and installers. In all versions of this model for sectional door, the springs are always of identical size and are calculated for a minimum of 30,000 cycles.

3.- CONSTRUCTION VARIANTS

Norpa, S.L. offers all possible options and solutions to problems that may be made when deciding on the purchase of a sectional door or installation for this type of enclosure :

WIDE RANGE OF WINDOWS with different shapes, sizes, finishes and decorations, entirely adequate and conforming to the panel model is used in its preparation.



PEDESTRIAN incorporate gateway implemented into the panel that makes up the sectional door. Can be found in its centred or displaced versions both with and without lower bottom socket (suitable for the disabled, prams, etc ...) can be manufactured to the left and right hand,



If the customer is looking for colours different to the standard sectional doors, Norpa, SL has a painting section that allows the coating of polyurethane paint of high performance of all its panels within the broad spectrum of RAL colour card, and stock of lacquered aluminium and steel in the same colours to match the final colour of the door.

DOORS WITH FULL VISION based panels with aluminium glazing to meet different customer needs. These strips of aluminium combined with methacrylates or transparent or translucent polycarbonate is made up of 5 different profiles

developed by Norpa, SL for this function can be combined with the usual sandwich panel sectional doors and acting in the same manner as in the operation of the enclosure.



4.- RAW MATERIAL

A.- SANDWICH PANEL

Monolithic isotropic sandwich panel constructed with an external base of galvanized steel sheet DX53D MAC Z-200 and pre-painted stucco embossed wood or 0.43 mm thick in accordance with the standards UNI EN 10327/10143 (*sheets and strips of low carbon steel for cold-formed, galvanized-coated, continuous hot dip. It is also possible the standard thickness of the coating-alloy iron-zinc (ZF) - from 100 to 600 μ in different finishes: normal star (N), minimum star (M), finished regular (A), improved finish (B) and finished higher (C)*), with rigid polyurethane foam insulation and structural function (*the rigid polyurethane is one of the most efficient thermal insulation materials and durable. Its low thermal conductivity given by the closed cell structure gives it an excellent energy efficiency*) of density 38 kg / m³ with tolerance ± 2 kg / m³ and a galvanized steel sheet inner DX51D Z-200 MAC pre-painted and embossed stucco thickness of 0.37 mm conforming to standards UNI EN 10327/10143.

The panels are manufactured with industrial traditional board and are available in thicknesses of 40mm and 500mm or 610mm high. This traditional board meets European safety standard EN12604.

The external side of the panel features a standard layout with V groove at intervals of 100mm from the centres (we have a single panel with V slot in the centre of the strip) on the inner surface intervals are repeated in the same way. At intervals of 610 panels are 120mm.

Both the upper and the lower panel are further strengthened from the interior, with reinforcements of galvanized steel DX51D Z-200 MAC 1.5mm thick and 30mm in width to allow effective clamping of the screws that attach to the intermediate and side hinges and avoid further drilling of these areas, which may weaken the panel.

To ensure airtight sealing of the door panel, the slats that comprise upper and lower door is finished with a lacquered steel profile (according to the color of the panels) bearing a profile of EPDM rubber to the wall at both ends. The references of both profiles are 60VA 93 for the bottom seal Profile 60VA 94 for top sealing profile.



The format of the sandwich panel is variable in terms of its length, with their standard widths (500mm and 610mm) and the value of its thickness 40mm and 80mm (cold rooms).

Weight of panel with 40mm internal reinforcement:

- 500mm in width: 10.5 kg / m², 5.25 kg / ml
- 610mm width: 10.2 kg / m², 6.22 kg / ml

Table of tolerances panel with 40mm internal reinforcement:

- 500mm in width: thickness ± 2 , ± 5 lengths off squad $\pm 3 \pm 3\%$ weight, deformation of the panel ± 3 mm in height and 0.2% of the width (length), tolerance curve of outer 2mm maximum symmetry final $\pm 1\%$ of the width of the panel (long), hollow 5mm maximum outgoing and incoming maximum 10mm, flat panel without visible defect when the panel is placed upright and seen from 1500mm in an arc of $\pm 60^\circ$ from the perpendicular.

Format of 610mm in width: thickness ± 2 , ± 5 lengths off squad $\pm 3 \pm 3\%$ weight, deformation of the panel ± 3 mm in height and 0.2% of the width (length), tolerance curve of outer 2mm maximum symmetry final $\pm 1\%$ of the width of the panel (long), hollow 5mm maximum outgoing and incoming maximum 10mm, flat panel without visible defect when the panel is placed upright and seen from 1500mm in an arc of $\pm 60^\circ$ from the perpendicular

The RAL 9010 white gloss finish of the inner face of 25 μ , smooth and paint of heat-hardened polyester is embossed in *stucco* during the manufacturing process of the panel.

The paint finish of heat-hardened polyester of 25 μ for the exterior is embossed with wood grain finish during the manufacturing process of the panel except in imitation wood (paint is substituted by a film of polyolefin / polyvinyl chloride semi-rigid 140 μ ($\pm 7\%$) decorated using rotogravure printing, embossed in wood finish or smooth), smooth poly grain (where the paint uses 35 μ -10 μ -primer it has better resistance to corrosion / UV and formability and is laminated without embossing)

Colour Chart (RAL card and) in sandwich panel Industrial model (traditional)

All Interior Side with RAL 9010.

Exterior -500mm and 610mm finished embossed stucco exterior / interior stucco embossed:

- RAL 9010 White RAL 8014 Brown
- RAL 9006 Silver RAL 9007 Grey Aluminium
- RAL 5010 Gentian Blue RAL 3000 Sunset red.



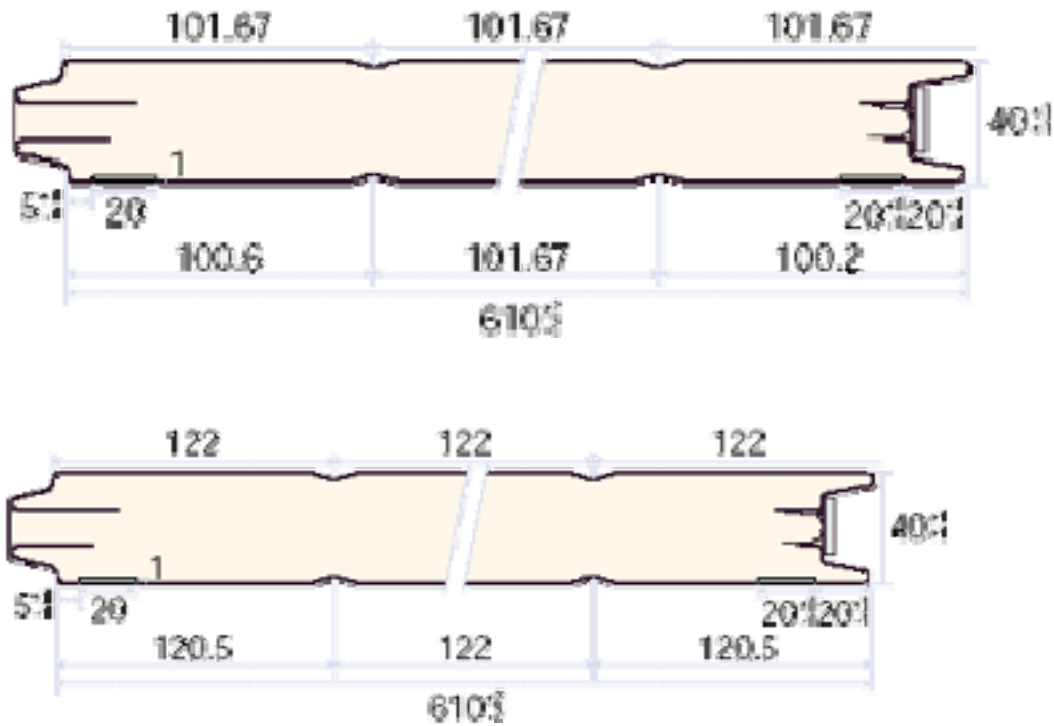

B.- GUIDE SYSTEMS OF STEEL

Guides consist of galvanized steel bends, half bends, guides and vertical profiles, horizontal profiles, joining pieces and end pieces shaped, bent and assembled by factory production process (profiling, bending, and riveting with robot and manual) with steel coils in thickness between 1, 1.5 and 2mm (based on model and target profile) in material finish DX51D Z-200 MAC / MB as standards EN10327 and EN10326.

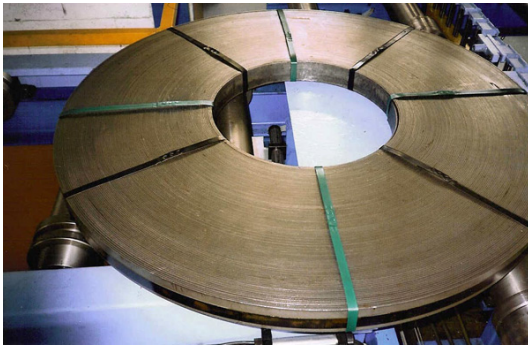

This galvanized steel cold-rolling and deep drawing is composed of a steel substrate on which a coating of zinc through a process of continuous galvanizing by hot dip immersion

The hot-dip galvanized steel provides excellent corrosion resistance and good forming ability in addition, the process model used for coating thickness of zinc deposit permits that can reach 275 g / m² (total both sides)

To ensure that the enclosure is airtight a profile of EPDM rubber is circulated along the vertical left and right that make up part of the guides, with reference 60-VA-101 side seal profile.



CHEMICAL ANALYSIS

	C (%)	Mn (%)	P (%)	S (%)	Si (%)	Al (%)	Nb (%)	Ti (%)
DX51D +Z EN 10327	≤ 0,120	≤ 0,60	≤ 0,100	≤ 0,045	≤ 0,50	-	-	≤ 0,300
DX52D +Z EN 10327	≤ 0,120	≤ 0,60	≤ 0,100	≤ 0,045	≤ 0,50	-	-	≤ 0,300

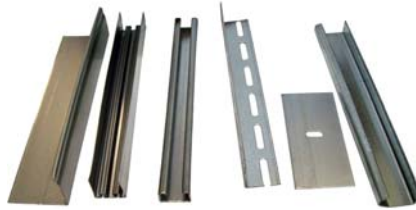

C.- TORSION SPRINGS

Torsion springs made of wire Phosphate colour black (C spring wire DIN 17223C - classification of material: 1.1002) in diameters from 5mm to 10mm based on the rules 18204 DGT, DGT 18205, BS 4637, BS 4638, BS 5216, DIN 17223 ASTM A 417M, ASTM A 227M and ASTM A 228M.

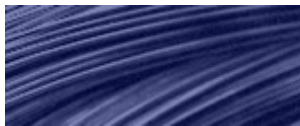

The wire springs Phosphate conforms to the standards EN10088-3, ISO 6931 and EN 10270-3. Respecting the rules of Montreal regarding the CFC and complies with European regulations on heavy metals. ISO TS 16949, ISO 9001 version 2000 and ISO 14001.

We manufacture industrial sectional door springs in diameters Ø50, 8mm thick with wire Ø5, Ø5, 5, OE6, OE6.5 and Ø7mm finish in standard black finish and galvanized (DIN 17223C wire Pier C - the classification of material: 1.1002) that have a high quality and are intended for industrial use; Ø95mm thickness of thread Ø7mm, Ø7. 5mm, Ø8mm, Ø8. 5mm and Ø9mm and Ø152mm thread Ø8mm in thickness, Ø8. 5mm, Ø9mm, Ø9,5mm Ø10



Parts of torsion springs to Ø95mm in aluminium, universal system. A piece composed by one fixed and one movable. Max. Torque: 157Nm Weight: 0.78 kgs per set.



Parts of torsion spring Ø50. 8mm aluminium with universal system. A piece composed by one fixed and one movable Max. Torque: 72Nm Weight: 0.28 kgs per set.

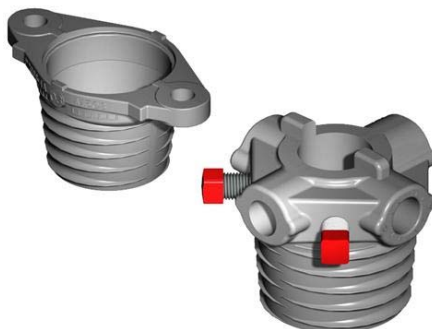

Parts for torsion springs Ø152mm aluminium with universal shaft Ø25, Ø31 and 4mm, 75mm. A piece composed by one fixed and one movable. Max. Torque: 226Nm Weight: 1.75 kgs per set.



Parts for torsion springs Ø152/Ø95mm aluminum with universal shaft Ø25, 4mm. A piece composed by one fixed and one movable Max. Torque: 226Nm Weight: 2.29 kgs per set..



The shafts are steel and presented in two versions Ø25,4 and Ø31.75mm (the axis is in manufactured in galvanized steel). Weight: 3.8 kgs / mtr for shaft Ø25.4mm, and 6.0 kgs / mtr for shaft Ø31. 75mm



D.- SAFETY SYSTEMS

All the safety systems used in our doors are patented and meet European standards for safety: Council Directive 89/106/EEC of 21 December 1988 on the approximation of laws, regulations and administrative provisions of Member States on Construction Products Norpa, S.L. uses the following safety systems:

- Safety anti-break device springs industrial TÜV approval Fv Tor 6 / 101. Peak torque 210Nm/spring. The piece-holder (bracket and extension) is zinc-plated steel 3mm thick and toothed wheel of cast iron. Its weight is 1.66 kg + 0.55 kg of the extension.



- Safety anti-break device of industrial cables (parachute) with TÜV approval Tor / Fv 6 / 102. Maximum weight 750 kgs door by using cable lifting 660 kgs Ø5mm and using cable Ø6mm lifting device. The piece is made of zinc-plated steel 3-4mm thick and its weight is 3.42 kgs.



E.- STEEL CABLES

Norpa Industrial sectional doors are raised by the action of a loop with a steel cable (towing) of Ø3mm Ø4mm, Ø5mm and Ø6mm around elevated drums . This is zinc-plated steel wire, its maximum force is 1770 N / mm² and is a type 7X19 +0. The weight per meter is 0.034 kgs for Ø3mm and 0.05 kgs in the Ø4mm. 0.09 for the Ø5mm and 0.13 en the Ø6mm The type of roll is a SZ crossing right .



F.- HARDWARE

The entire range of fittings that is used in the door meet European standards CE EN-13241-1. This set of hardware consists of (as per model):

DRUMS. Aluminium Die Cast with 0.5 or 2 safe turns of security Cable with through cable anchor slot reinforced at base.

Specification of Drum 1350-28 RH / LH of aluminium die-cast for shaft $\text{Ø}31$, 75mm cable and lift up $\text{Ø}6\text{mm}$. Weight 4.21 kgs per unit (one mounted left and right). The maximum height of the door is 8401mm to 0.5 turns up the cable lift and 6929mm to 2.0 turns up the cable lift. Maximum Door Weight: 1000 kgs. Total internal drum diameter: 341.5 mm. Drum Height: 171.5 mm. Bearing distance: 190mm

Hinges intermediate panel traditional industrial zinc-plated steel 2.5 mm thick. Weight: 0.12 kgs



Zinc-plated steel hinges lateral 2.5 mm thick for traditional industrial panel carrier rollers rollers $\text{Ø}11\text{mm}$. Weight: 0.44 kgs



Industrial Coupler of steel $\text{Ø}25$, $\text{Ø}31$ and 4mm, 75mm Weight: 1.33 kgs ($\text{Ø}25$, 4mm) or 1.93 kgs ($\text{Ø}31$, 75mm)



Zinc plated steel rollers with $\text{Ø}46\text{mm}$ Nylon wheel and ball bearing and steel $\text{Ø}11\text{mm}$ shaft L = 90mm or 168mm Weight: 0.2 kgs. Maximum load: 35 kgs to 750,000 revolutions.



Components for window:

Aluminium:

High profile:

Low profile

Closed Side profile:

Profile separation central ref.

Profile setting for the piece methacrylate / polycarbonate:

The aluminium profiles are painted in any shade of the wide spectrum of RAL color card.



Other components:

Adjustment for the rubber piece methacrylate / polycarbonate: ref. 4117557-35 Rubber internal glass 7mm



Methacrylates: PLEXIGLAS acrylic glass

Its transparency, lightness, impact resistance, thermal insulation and resistance to the weather and the passage of time, make it a versatile material with respect to applications whose functionality is appreciated by the naked eye. Features:

- Transparency of around 93%. The most transparent of plastics.
- High impact resistance, about 10 to 20 times that of glass.
- Resistant to weather and ultraviolet rays. There is no appreciable aging in 10 years of exterior exposure.
- Excellent thermal and acoustic insulation.
- Lightweight compared to glass (about half) with a density of about 1190 kg/m³ is only slightly heavier than water.
- hardness similar to that of aluminium: scratches easily with any metal object such as a clip.
- Easy combustion does not turn off when removed from heat. Its gases have a fruity smell and crackle to burn. Produces no toxic gas to burn so it can be considered a very safe product.

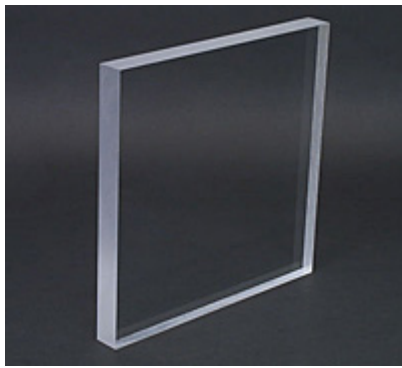

Polycarbonates: The Compact Polycarbonate has excellent mechanical properties, being almost unbreakable. Among its main features:

- Supports a wide range of temperatures from -40° to $+135^{\circ}$
- Protected against ultraviolet radiation in outdoor applications.
- Self-extinguishing fire.
- Density: 1.20 g / m^3
- Melting point $250^{\circ} \pm$
- Refractive index: 1.585 ± 0.0001
- Rate of light transmission $90\% \pm 1\%$

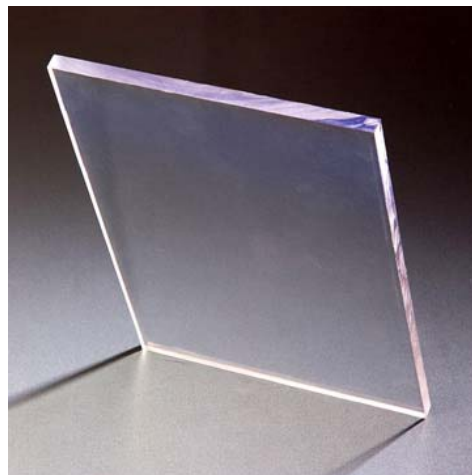

5.- EUROPEAN TECHNICAL REGULATIONS ACCORDING TO EC-13241-1

Norpa, S.L. has verification and certification for its single metal sheet residential door which give the following data:

Test of fully assembled door

- 1.1 WIND RESISTANCE: CLASS 4
- 1.2 AIR PERMEABILITY: CLASS 3
- 1.3 WATER TIGHTNESS: CLASS 3. Max Pressure 70PA

ACCOUSTIC VALUE- Sound reduction 25db

1.4 Thermal resistance

Door (panel) type	Thermal transmittance, $W/(m^2K)$	
	without windows $U_{door} =$	with windows $U_{door} =$
Seccional Industrial PB	1.2	1.2

1.2 Determination of air permeability

Door panel type	Air permeability class
Seccional Industrial PB with three windows type TorqueForce no. 85602	3

1.3 Resistance to water penetration

Door panel type	Water penetration class	Maximum pressure [Pa]
Seccional Industrial PB with three windows type TorqueForce no. 85602	3	70

1.4 Thermal resistance

Door (panel) type	Thermal transmittance, W/(m ² K)	
	without windows $U_{door} =$	with windows $U_{door} =$
Seccional Industrial PB	1.2	1.2

1.5 Operating forces, Safe opening, Dangerous substances and Durability of water tightness, thermal resistance and air permeability

Product name	Requirement	Result	Test Report
Industrial door	Operating forces *	Pass	
	Safe opening	Pass	
	Dangerous substances	Pass	
	Durability of water tightness, thermal resistance and air permeability	Pass	

* See different operators, chapter 3 in this report.

6.- VARIATIONS IN GUIDES

For perfect adaptation of the door to the site where it has to be installed, Norpa makes its residential door in 5 standardised guide versions, creating a perfect fit between the door and the garage space . ANNEXE- DRAWINGS. **E**